

180 min

EAC

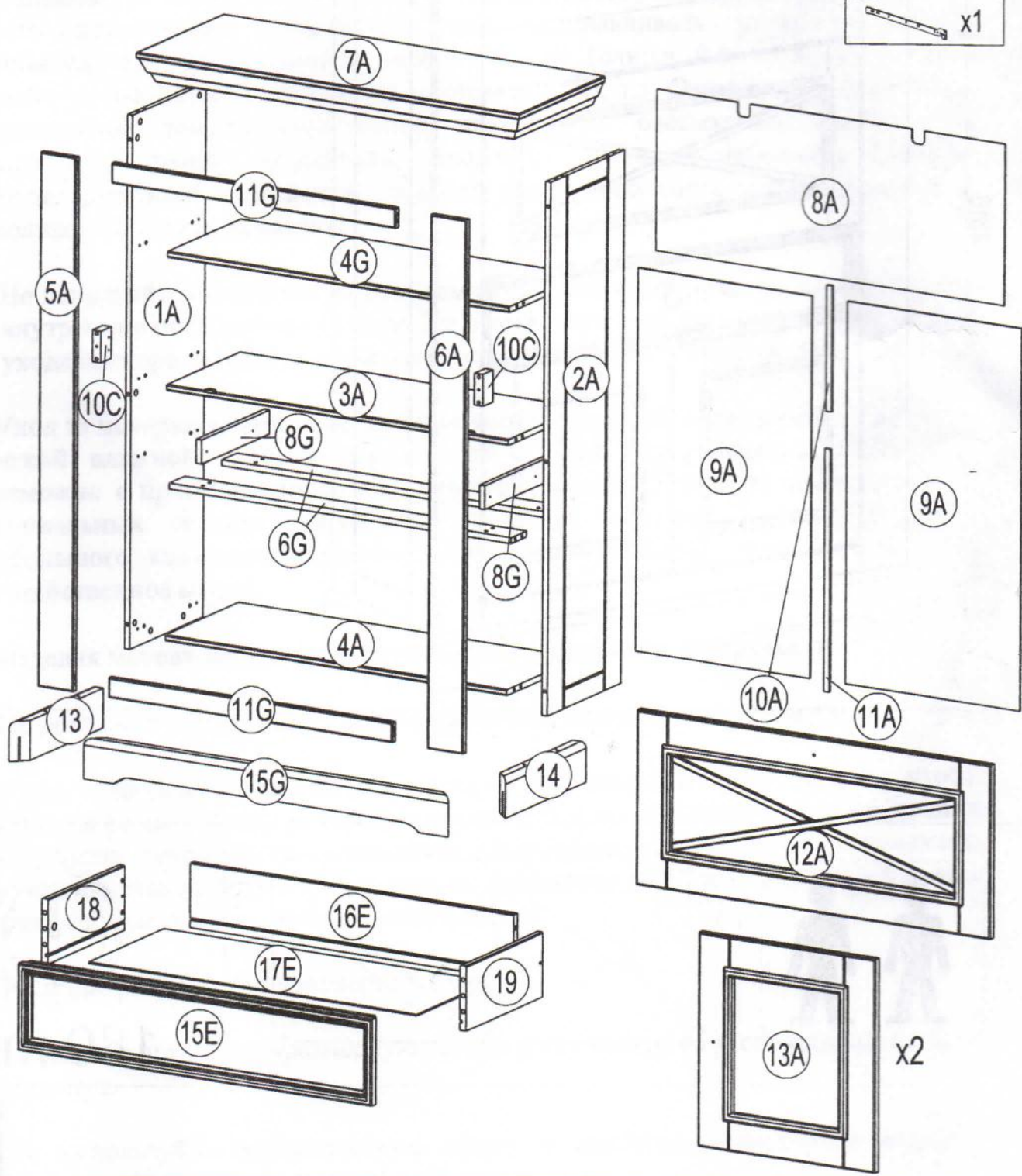

1

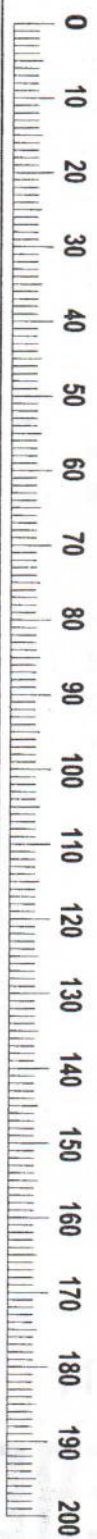
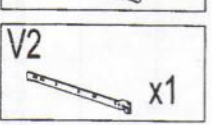
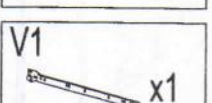
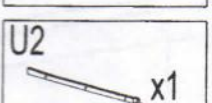
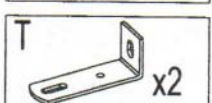
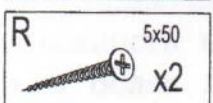
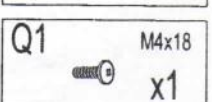
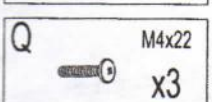
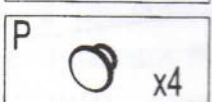
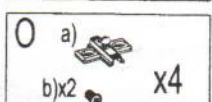
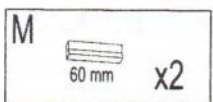
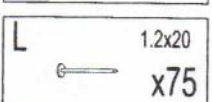
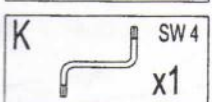
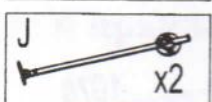
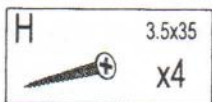
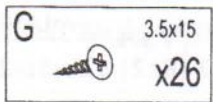
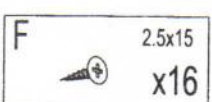
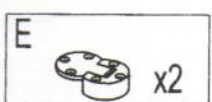
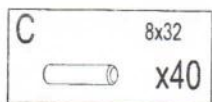
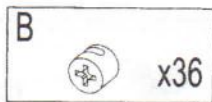
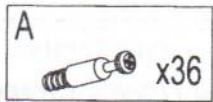
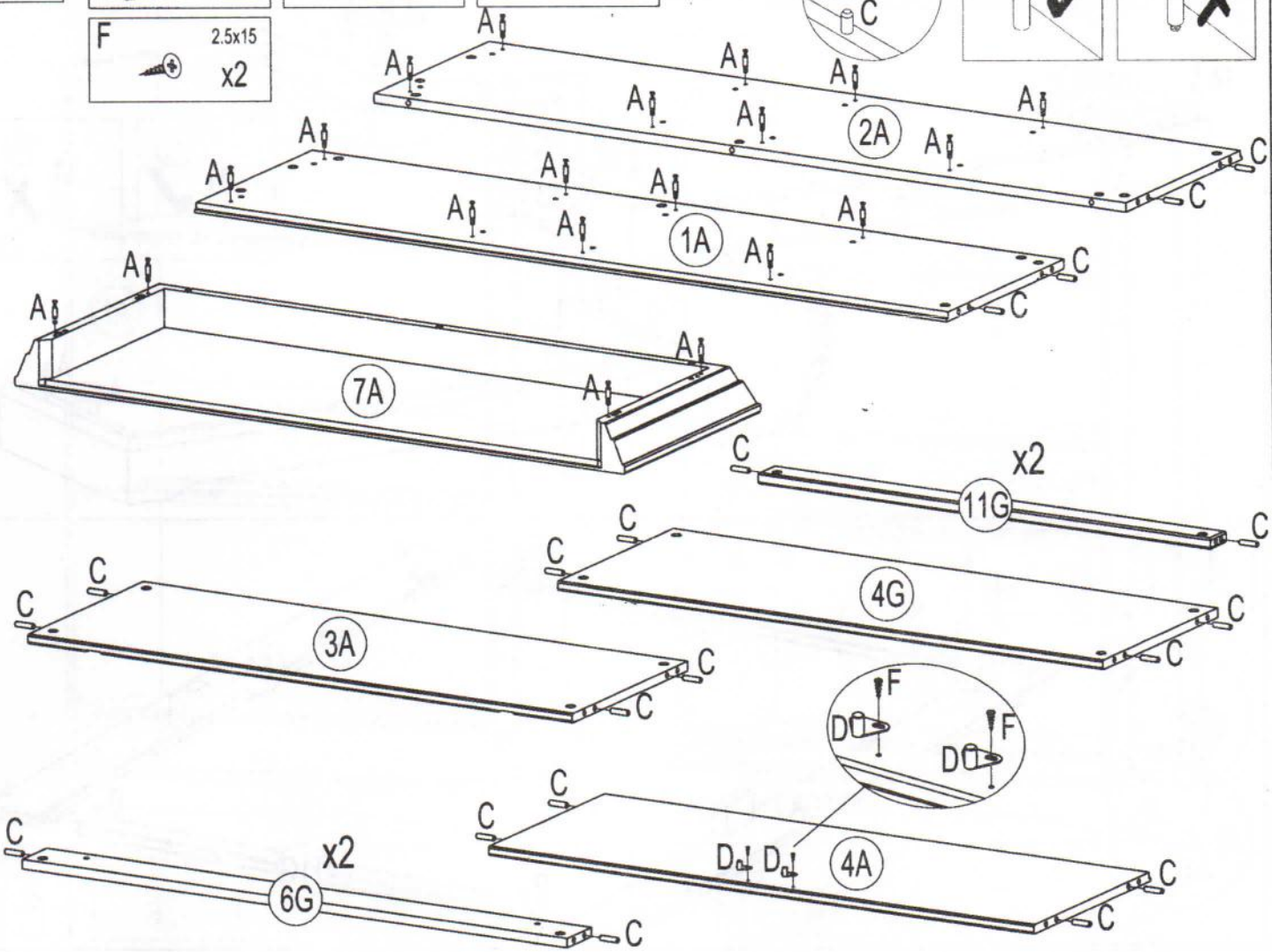
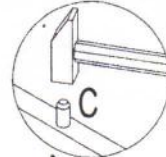
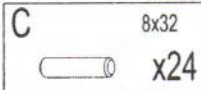
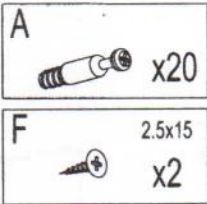

2

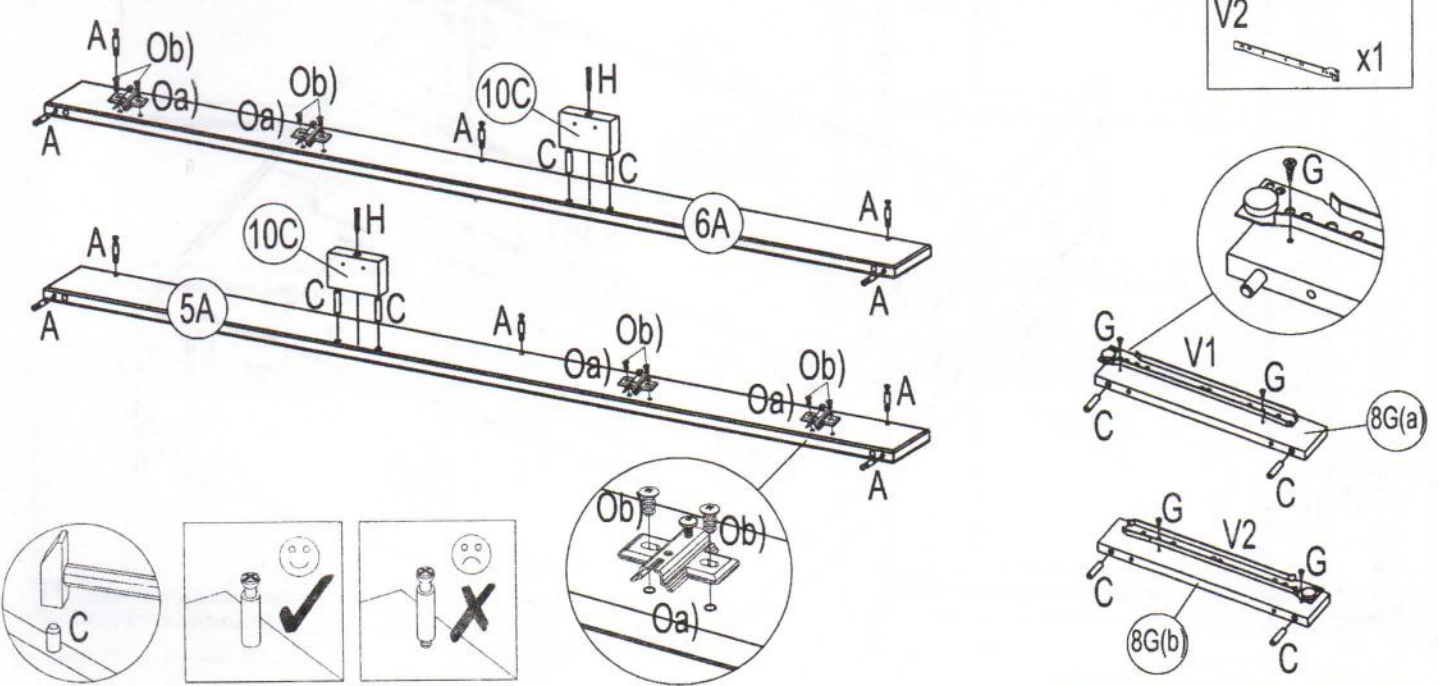
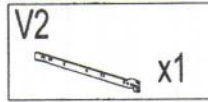
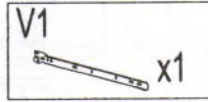
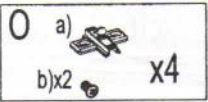
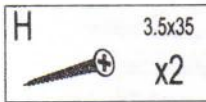
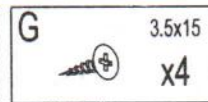
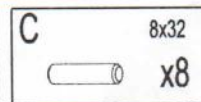
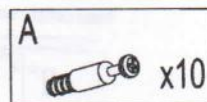

3

3

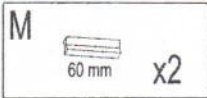

M

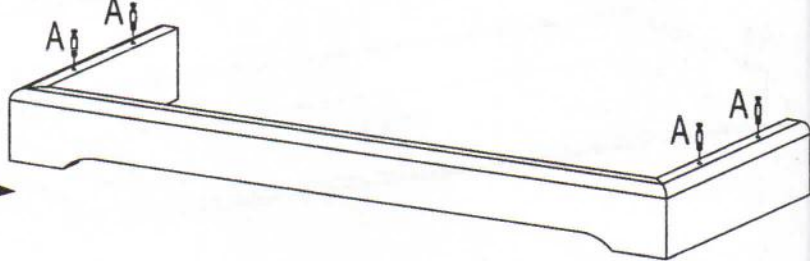
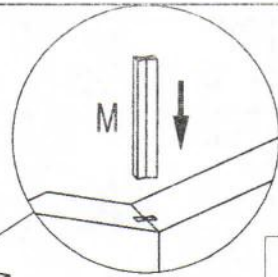
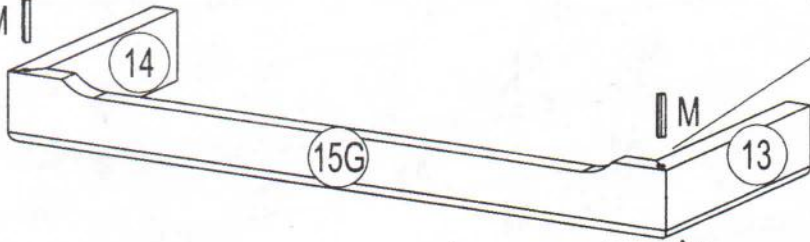

4

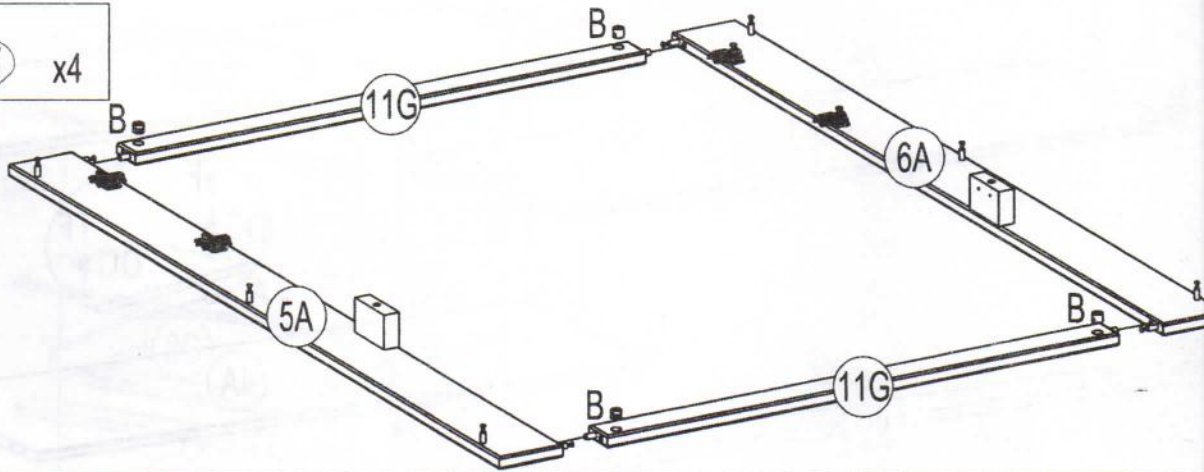

5

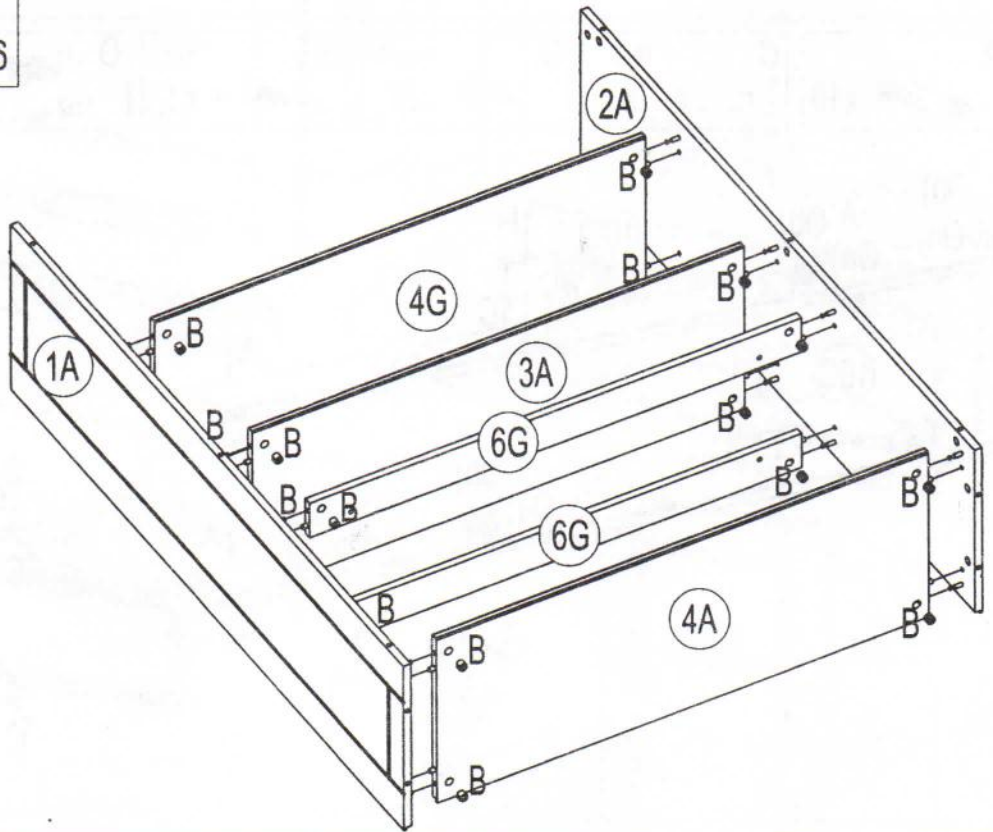
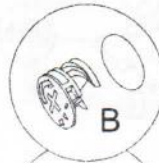
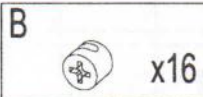

6

B x4

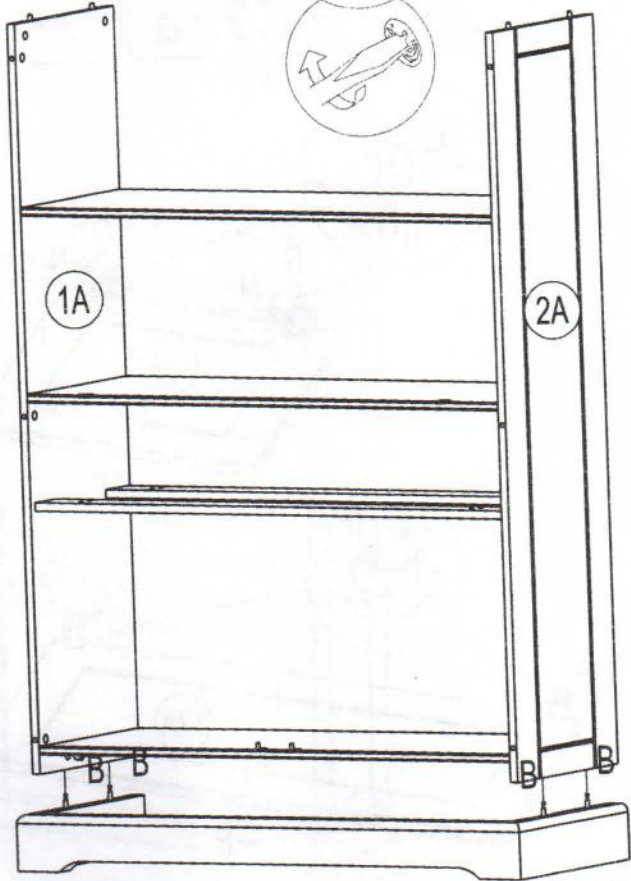
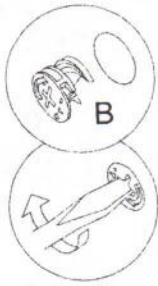

7

I x4

K SW4 x1

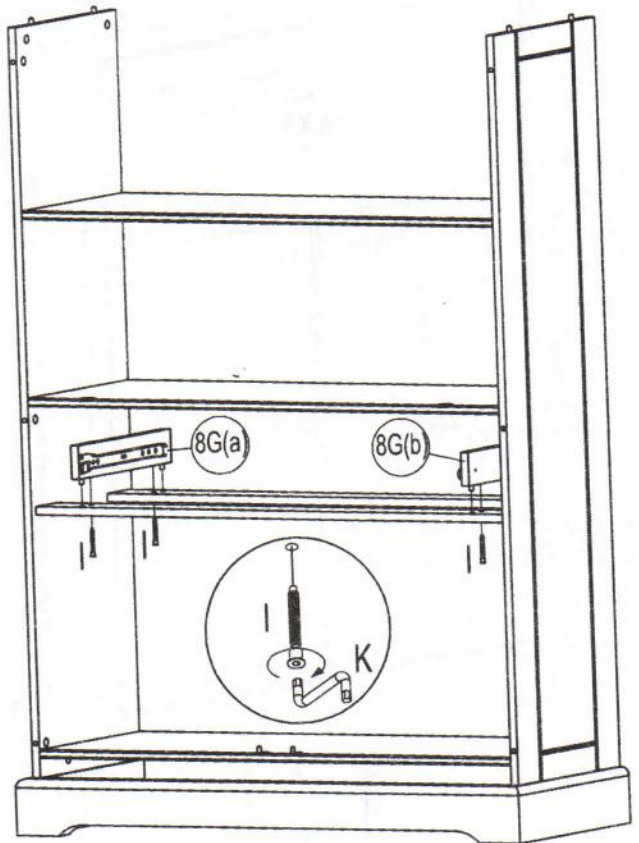

8

B x4

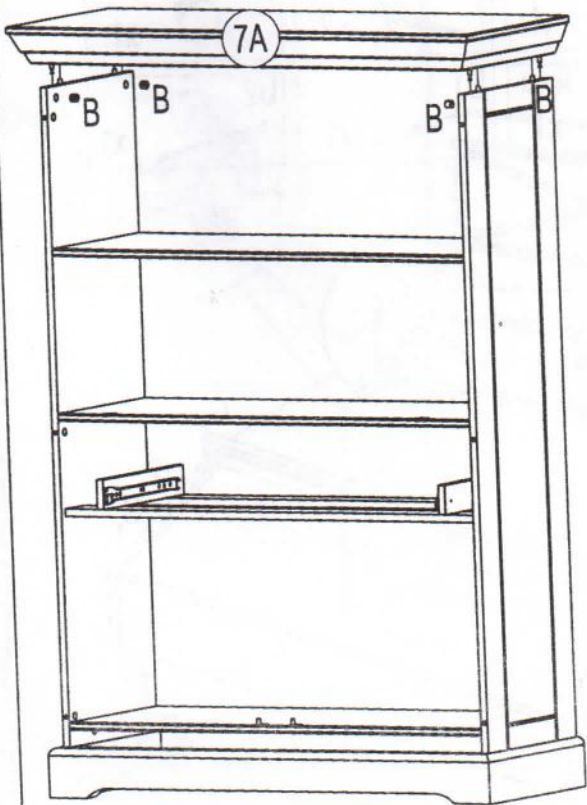

9

B x6

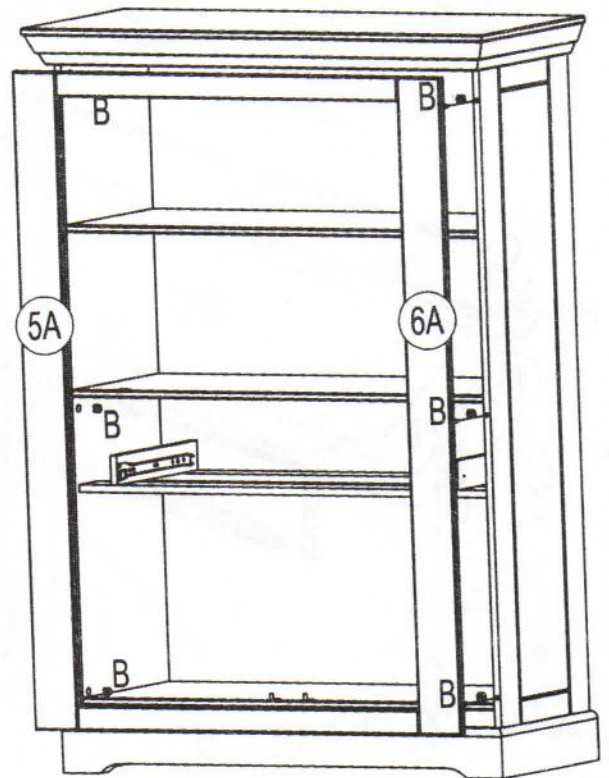
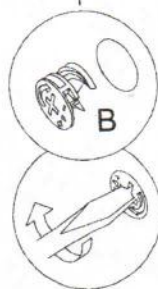

5

10

L 1.2x20
x75

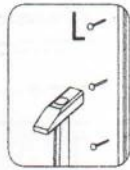
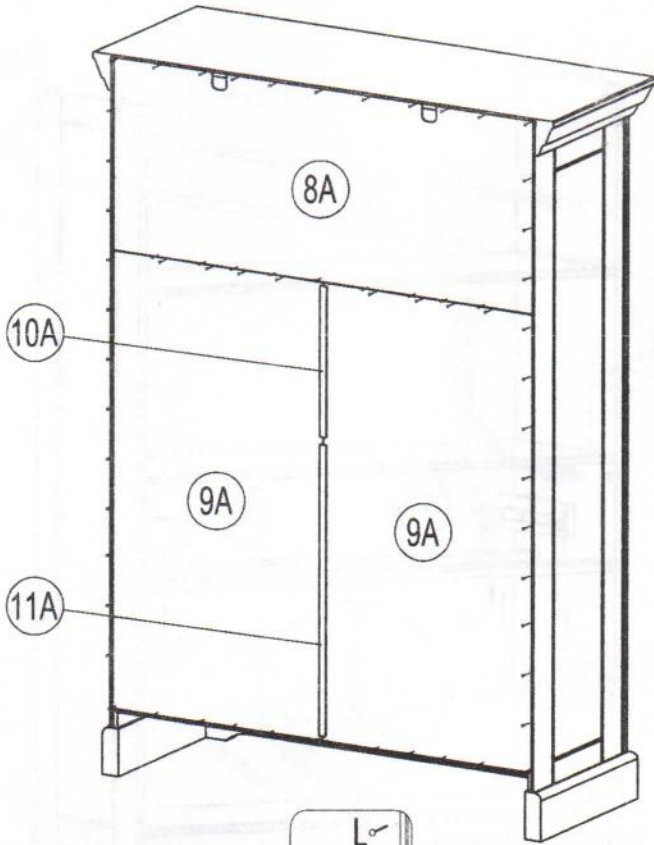

11

E x2

F 2.5x15
x12

G 3.5x15
x8

N x4

P x3

Q M4x22
x3

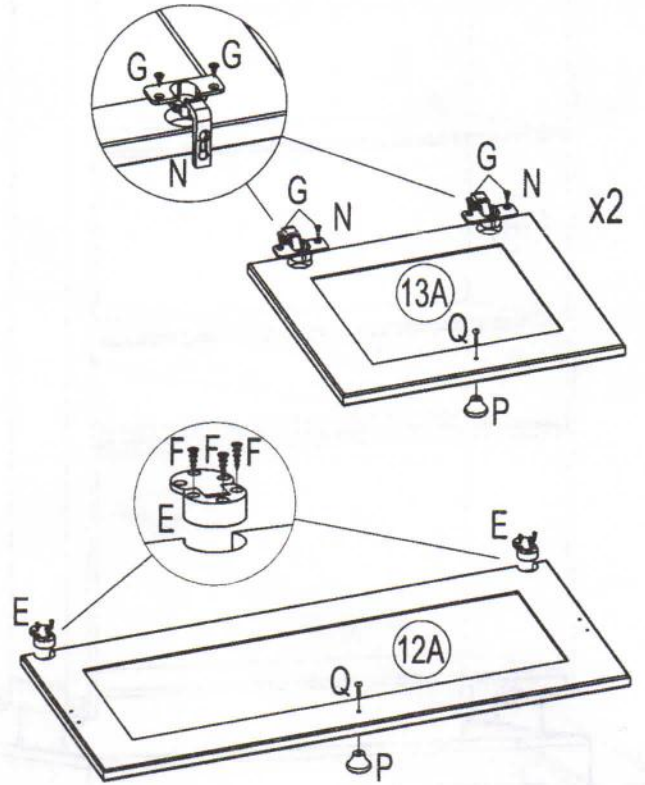

12

A x2

B x2

C 8x32
x8

G 3.5x15
x4

H 3.5x35
x2

P x1

Q1 M4x18
x1

U1 x1

U2 x1

